

Code number	M0600-01
Groove density	600grooves/mm
Wavelength range	400-1400nm
Dimensions	Ø50mm
Central thickness	7mm

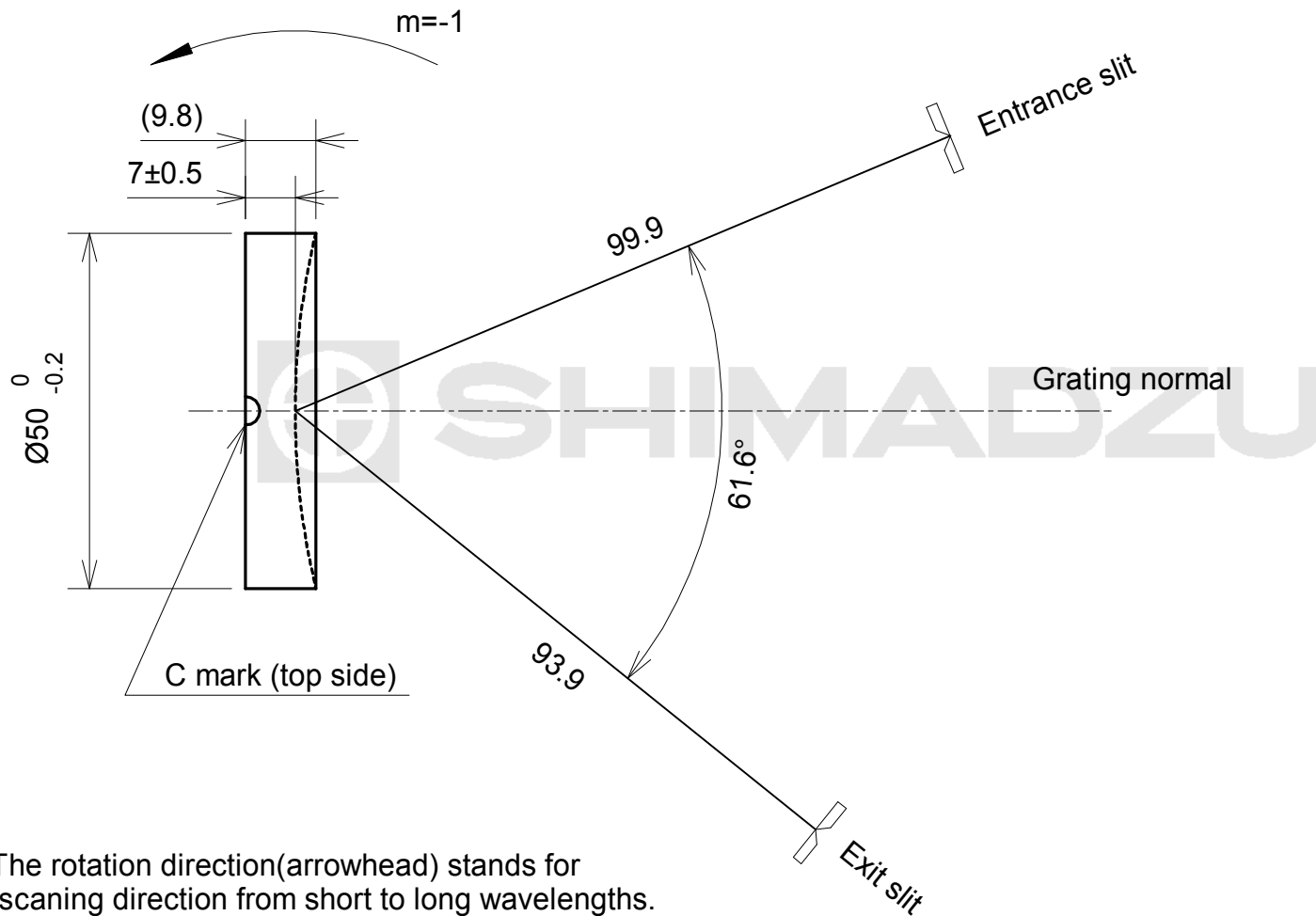

The rotation direction (arrowhead) stands for scanning direction from short to long wavelengths.

C mark : Indentation on rear side to indicate mounting direction